

## sliding shaft instruments



## customize handle style - 2

Custom designs can be manufactured in a timely and economical manner.



Finger Ring Handle  
handle height: 4"



Ferris-Smith-Kerrison Ring Handle  
handle height: 5"

Handles shown on this page are standard styles and sizes.

Each handle can be customized according to your specifications.

Your logo can be placed on the instrument.

Contact gSource Customer Service for any questions.







Ferris-Smith-Kerrison Handle  
handle height: 5"



Ferris-Smith-Kerrison Silicone Coated Handle  
handle height: 5"

Biocompatible silicone coated handles are available in five standard colors:

brown	
blue	
lavender	
turquoise	
green	

Or, in custom colors of your choice according to your specifications.



Kerrison Handle  
handle height: 6"



Love-Kerrison Standard Handle  
handle height: 6"



Love-Kerrison Handle  
handle height: 6"

# customize shaft length and working end - 3

## A Bite Styles

### Rongeur Styles

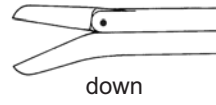
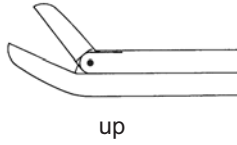
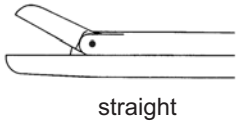

### Punch Styles - Regular Foot Plate

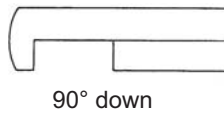
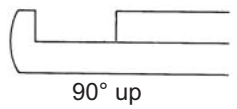
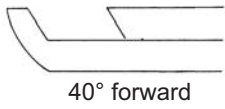

### Punch Styles - Thin Foot Plate

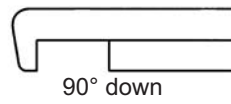
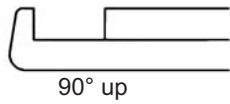
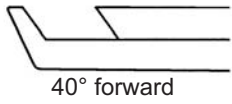

Customize:

A - Bite Style

B - Bite Size

C - Bite Opening

D - Foot Plate

E - Shaft Length

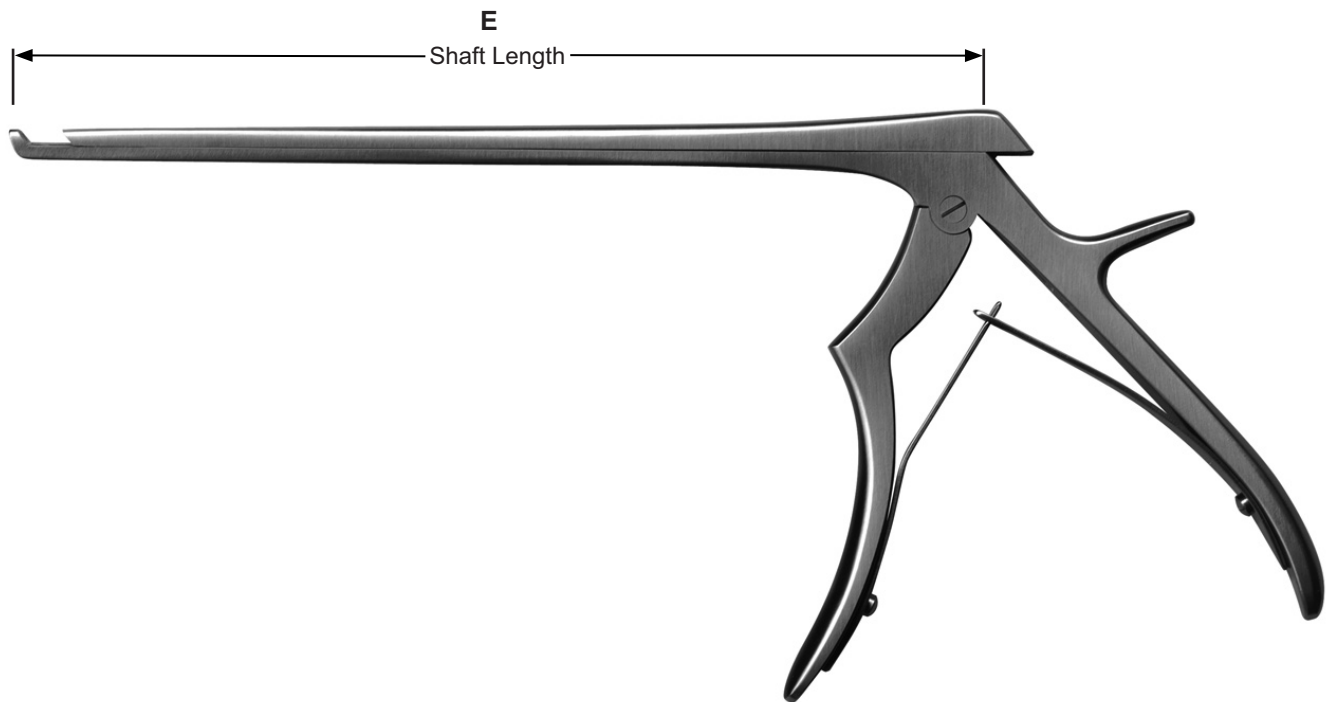
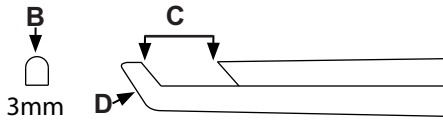

## 4 - customize shaft style and add coating

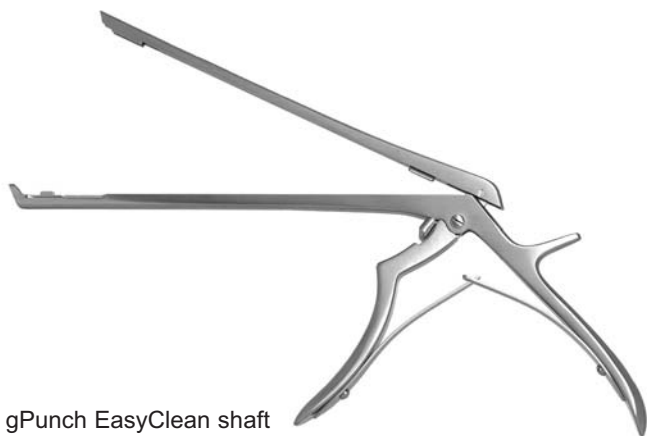

gPunch EasyClean shaft

Designed to open and close easily for complete cleaning inside shaft, helping to reduce the risk of infection.

- Punch remains in one piece when opened so there are no loose instrument components.
- Forward or up angle provides precise cutting action.
- Bone ejector can be incorporated into the design.
- Custom options available upon request.

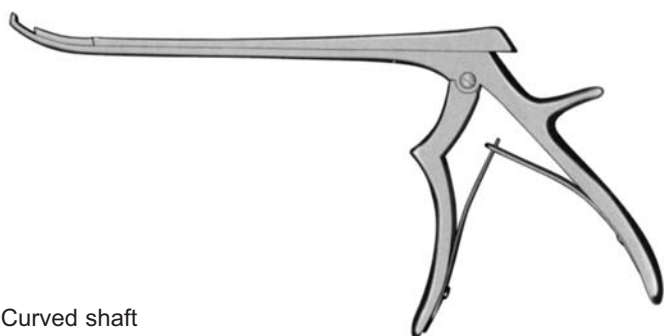

Curved shaft

Curved shaft and forward angled foot plate make the underside of the foramen accessible. Hinge at working end of upper shaft enables a smooth cutting function.

- Curve can be customized to your specifications.
- Curve angle options include slight, strong, left or right.

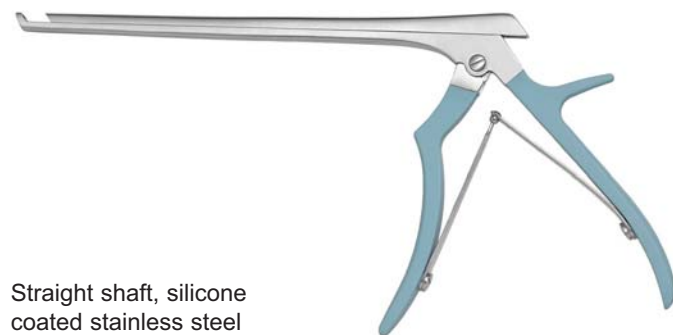

Straight shaft, silicone coated stainless steel

Biocompatible silicone coated handles help to prevent slippage and provide a secure grip.

- Colored handles provide easy bite size recognition.
- Available in five standard colors according to bite size (brown, blue, lavender, turquoise, green) or custom colors of your choice.
- Silicone has excellent resistance to alkaline, saline and acidic solutions.
- Non-fading vibrant colors withstand repeated autoclaving.



Bayonet shaft, titanium nitride coated

Titanium nitride (TiN) coating on shaft instruments can be used to harden and protect the cutting and sliding surfaces.

- Available in black, gold, bronze or similar.
- Non-fading colors withstand repeated autoclaving.

The bayonet style shaft is designed to provide optimized visibility during surgical procedures.

customize working ends - 5

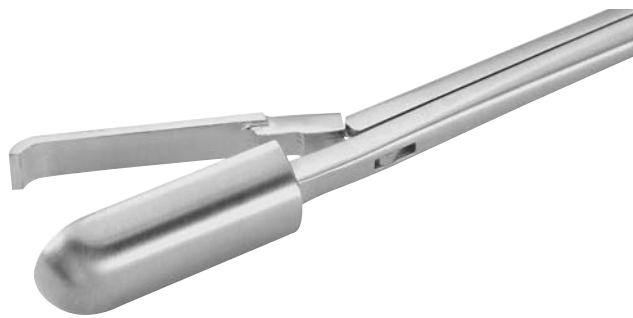
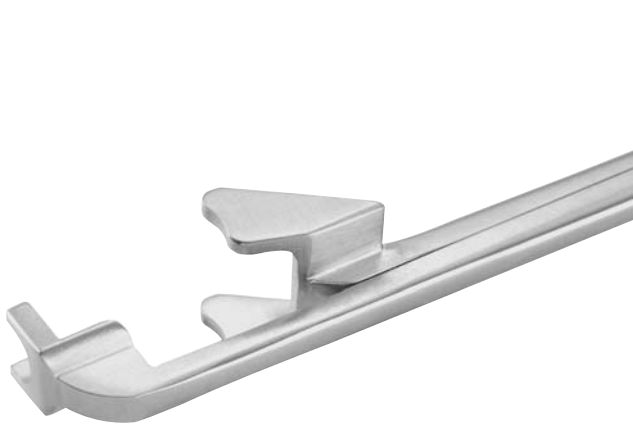

6 - custom options available



custom options available - 7



## **gSource**

gSource is committed to putting the finest instruments into the hands of surgeons and their teams.

Not all instruments are created equal. Adequate for the job is, in reality, inadequate. A better instrument reduces distractions and facilitates operations. A better instrument helps a surgeon perform at his/her best. A better instrument leads to better results. gSource provides better instruments.

### **gSource Instrument Attributes**

Whether crafted from German surgical stainless steel, or machined from U.S. surgical stainless steel, our instruments are recognized by their finely finished surface. They are designed to perform with precise surgical function and are also conceived to be affordable. It is this combination that distinguishes a gSource manufactured instrument.

### **gSource Verified Quality**

Every gSource instrument must pass detailed Quality Assurance tests before it can be sold. Instruments are tested for quality of material, workmanship, function, pattern consistency and critical dimensions.

### **Custom Instrumentation**

Custom designs can be manufactured in a timely and economical manner. For an accurate quotation and delivery schedule, send us a sample, sketch or drawing.

### **Standard Instrumentation**

Most standard instruments are available from stock. For a complete listing, request a copy of our reSource catalog or explore our website at [www.gSource.com](http://www.gSource.com). For a quotation, fax or e-mail us a copy of an instrument depiction or name and part number.

### **Guarantee**

All standard instruments are guaranteed for life against manufacturing defects of material and workmanship. Any instrument proving to be defective will be replaced or the purchase price refunded.



gSource, LLC  
19 Bland Street  
Emerson, NJ 07630  
USA

P (800) 978-1119  
(201) 599-2277  
F (201) 599-3306  
E [email@gSource.com](mailto:email@gSource.com)  
[www.gSource.com](http://www.gSource.com)

## **Service First**

Your inquiries will be answered quickly and accurately by knowledgeable professionals.

## **Trusted Supplier to World Leaders**

Many world leaders and innovators in orthopedics and spine have found in gSource a trusted and reliable partner. We provide superior instrumentation in a time critical fashion and at realistic prices. From prototypes to full-run production, we are committed to being a valuable business partner, always providing a real return on investment.

## **What our Customers Say about gSource**

"You are the first supplier I go to when searching for an instrument due to your excellent leadtimes and pricing."

"Thank you for providing us with quality instrumentation on a tight schedule. We completed four successful surgeries last week with the instruments you produced, which will improve the lives of four people, with many more to follow."

"Customer service professionalism as well as response to questions has always been excellent."

"Very pleased with the quick turnaround."

"gSource has been, and continues to be a solid supplier; with the best interest of their customers driving them. It is a pleasure to do business with gSource."

## **gSource Advantages**

- Realistic price
- Verified quality
- German craftsmanship
- Precise U.S. machining
- On-time delivery
- Orthopedic and spinal focus
- On-site product development
- CAD support
- Custom labeling and packaging
- Custom marking
- Large selection and inventory of standard instruments
- Adaptability/Flexibility
- Superior customer service
- Full satisfaction guarantee